

Mil Mi-17TB

'Hip'



ART BY ADAM MARCINIAK

www.mistercraft.eu

F-01

Short history of the Mi-8 Helicopter. The Mil Mi-8 is not only the most versatile helicopter in the world, but also the one that has been built in greatest numbers. The numerous variants of the production Mi-8 helicopter has been used for all conceivable applications. In the civil sector they extend from passenger flights through rescue missions, transport to the remotest regions of the Arctic, VIP travel, to fire extinguishing and use as a flying crane. In the military sphere it is used mainly as a transport for troops and equipment. In addition the Mi-8 saw service as an electronic combat aircraft, as a flying command post for tank units and other vehicles, for anti-ship missions and finally as a combat helicopter capable of releasing bombs, unguided missiles in UB 32 rocket pods or guided anti-tank missiles. The birth of the Mi-8 did not give rise to any great hopes. The new machine demonstrated its qualities shortly after its maiden flight, when it set two new world records: 201.8 km/h on a 2000 km stretch and a range of 2465.7 km on a closed circuit. These were not the only world records that would be set by the new helicopter. Series production of the machine, now designated the Mi-8, began in 1965 at Helicopter Works no. 387 in Kazan. By 31.12.1999, 4066 of the Mi-8 in various versions had been built at Kazan. Of these 1750 were sold in over 40 countries throughout the world. To meet demand, in 1970 Aircraft Factory No. 99 in Ulan-Ude set up a further production line for the Mi-8 which ceased production in 1999 having produced 3700 machines. A special version of the Mi-8 range was the Mi-8TB combat helicopter that could carry bombs from 50 kg to 500 kg on six external stations. It was even possible to carry 2x 500 kg bombs and two UB 32 rocket pods each carrying 32 S-5 rockets. In addition it had a 12.7 mm cannon in the nose. This version was only used by the Soviet armed forces. For East Germany an export version exclusive to the Warsaw Pact was built under the designation Mi-8TB which was also used in navy helicopter squadrons. The normal version of the Mi-8T could also be armed with four external racks for combat purposes. Four UB 16 rocket pods each with 16 S-5 rockets were used. Following the reunification of Germany a whole range of former East German Mi-8s were taken over by the Federal German Army, to be used mainly for SAR missions, and went into service in 1995. In 1995 six of these machines were bought from the German air rescue service to set up an air rescue system in Estonia. Technical data of Mi-8T: Fuselage length: 18.17 m, Height with rotor head: 4.755 m, Overall height: 5.65 m, Rotor diameter: 21.29 m, Power plant: 2 x Isotov TW2-117A, Capacity: 2 x 1700 shp, Weight empty: 6934 kg, Normal take-off weight: 11,100 kg, Max. take-off weight: 12,000 kg, Max. external load: 3,000 kg, Max. speed: 260 km/h, Cruising speed: 225 km/h, Service ceiling: 4,500 m, Normal range: 465 km, Armament: (Armed version): 4 x UB 16 each with 16 S-6 rockets.

●GB. Marking and Painting Guide ●D. Markierung und Bemalanleitung ●PL. Oznaczenie i Malowanie ●F. Peinture et marquage Guide ●NL. Schilderen en markeringen gids

●ESP. Pintura y Guía de Marcas ●POR. Pintura e Guia de Marcas ●I. Pittura e Guida Marcature ●S. Målning och märkning Guide ●FIN. Maalaus ja merkinnät opas

1 Mil Mi-8T LLP (Ludowe Lotnictwo Polskie) Polish Air Force Warszawa, Leczyca A.B. 1960s

2 Mil Mi-8T Военно Воздушни Сили, ВВС Москва, СССР 1980 Soviet Air Force, Moscow, 1980s

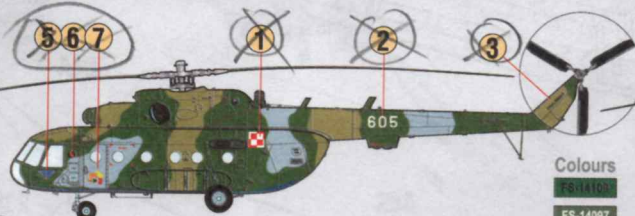

Colours
 FS-11009
 FS-14097
 FS-13637
 FS-15102

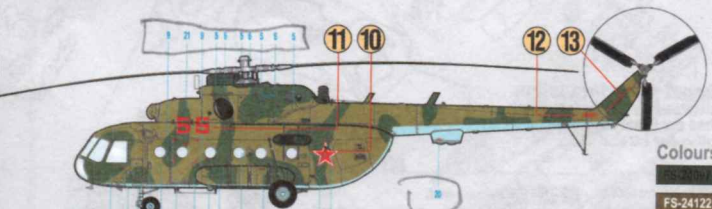

Colours
 FS-24122
 FS-33434

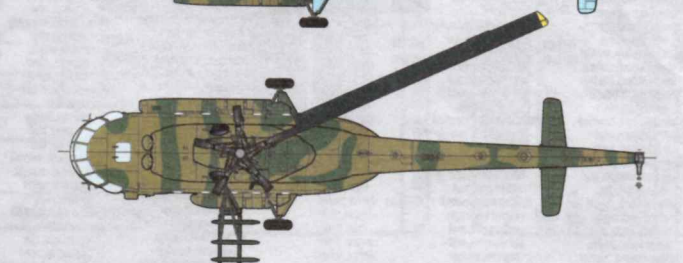
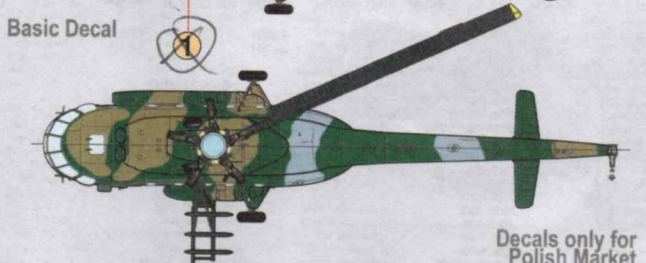
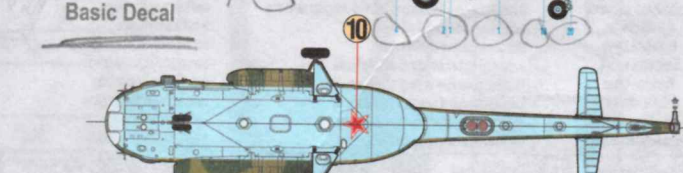
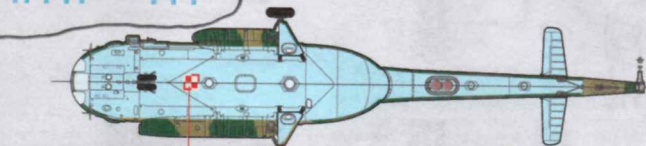
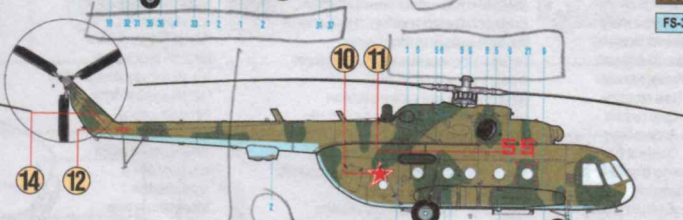

Basic Decal

Basic Decal

Decals only for Polish Market

GB.Assembly instruction

- D.Montageanleitung
- PL.Instrukcja montażu
- F.Notice de montages
- Cz.Montážní návod
- Инструкция по монтажу

Instrument Panel Painting
Malowanie Tablicy przyrządów
Bemalung des Sitz
Peinture du Siège
Pintura del Asiento

Cocpit Assembly
Montaz Kabin Pilot
Zusammensetzung der Sitz
Montage l' Poste du Pilotage
Montaje de la Cabina

- Glue Kleben
- Przykleić Collier
- Lijmen Engomar
- Colar Incollare
- Limmas Limaa
- Limes Lim
- Клеить коллери
- Yapıştırma Yapıştırma
- Lepeni Lepleni
- Lepiti Lepiti
- Lipici лепило
- клеи клей

1 STEP

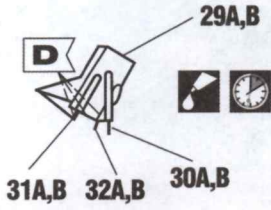

2 STEP

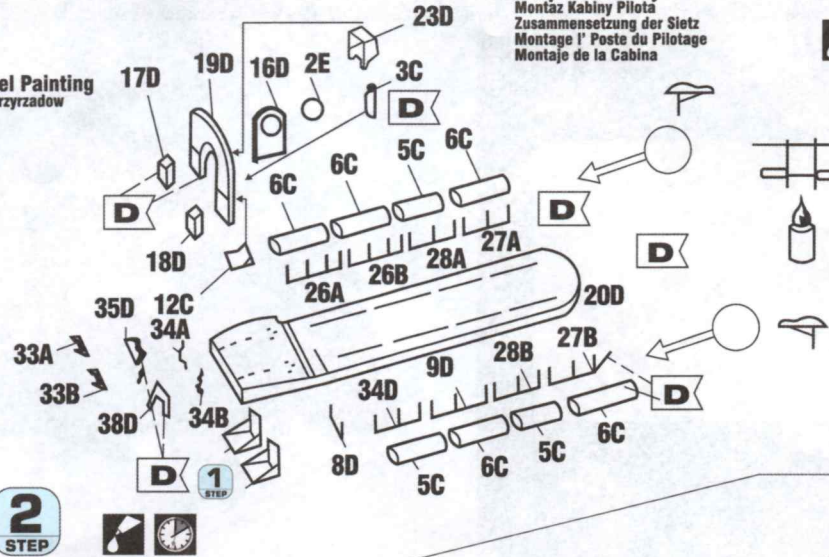

3 STEP

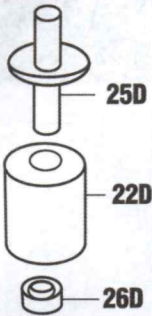

4 STEP

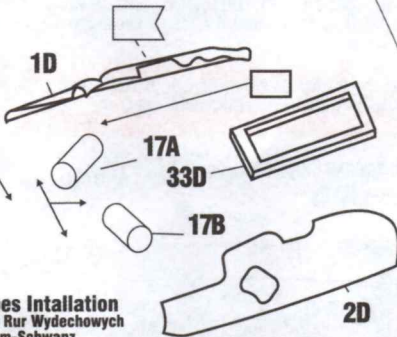

Exhaust pipes Intallation
Zainstalowanie Rur Wydechowych
Einbau der Beam-Schwanz
Fixation des Largeur Tail

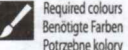

Soak and apply decals
Abziehbild in Wasser einweichen und anbringen
Zmęczyć kalkonię w wodzie a następnie nakleić
Mouiller et appliquer les décalcomanies
Transfer in water even laten weken en aanbrengen
Remojar y aplicar las calcomanías
Pôr de molho em água e aplicar o decalque
Immergere in acqua ed applicare decalcomanie
Blöt och fäst dekalerna
Kostuta siirtokuvaa vedessä ja aseta paikkaleen
Fukt motivet i varmt vatten och fäst det över på modellen
Dypp bildet i vann og sett det på
Переводную картинку намочить и нанести
Βουτηξτε τη χαρτοκιτριά στο νερό και τοποθετήστε τη
Çikartmayı suya yumuflatın ve koyun
Obtisk namočit ve vodě a umístit
a matrică în apă caldă și să o aplici
Preslikač potopiti v vodu in zatem nanašati
Rum-Se Immoaie și se aplică decalcomani
BUL-Намиснете и прилагане на водени
UA Замочити і застосувати наклею

Number of working steps
Anzahl der Arbeitsgänge
Liczba operacji
Nombre d'étapes de travail
Het aantal bouwstappen
Het aantal bouwstappen
Número de operaciones de trabajo
Número de etapas de trabalho
Numero di passaggi
Antal arbetsmoment
Työväleiden lukumäärä
Antall arbeidstrinn
Antall arbeidstrinn
Количество операций
αριθμός των εργασιών
İş safhalarının sayısı
Počet pracovních operací
a munkafolyamatok száma
Številka koraka montaže
Numărul de etape de lucru
Брой работни стъпки
Кількість робочих кроків

A Dark green, matt
dunkelgrün, matt
Ciemnozielony, matowy
vert foncé, mat
donkergroen, mat
verde oscuro, mate
verde escuro, fosco
verde scuro, opaco
mörkgrön, matt
tummanvihreä, himmeä
markgrön, matt
markgrön, matt
темно-зеленый, матовый
Práovno okóuro, jatt
Koyu yeşil, mat
tmavozelená, matná
szétféle, matt
temnozelená, mat
verde închis, mate
тъмно зелено, матово
темно-зеленый, матовый
黒色マット

B Light blue, matt
lichtblau, matt
Jasnoniebieski, matowy
lichtblau, mat
azul celeste, mate
azul celeste, fosco
azul celeste, opaco
juská, matt
vaaleansininen, himmeä
lyséblá, matt
lyséblá matt
светло-голубой, матовый
jmlé fútsó, jatt
slyah, mat
svélemodrá, matná
fékete, matt
črna, matt
negru, mate
черен, матово
чорний, матовый
フランク, マット

C Black, matt
schwarz, matt
Cazru, matowy
noir, mat
zwart, mate
negro, mate
negro, fosco
nero, opaco
svart, matt
musta, himmeä
sort, matt
sort, matt
черный, матовый
jaipuro, jatt
slyah, mat
černá, matná
fekete, matt
črna, matt
negru, mate
черен, матово
чорний, матовый
フランク, マット

D Dunkelblau, matt
dark blue, matt
Ciemnoniebieski, matowy
bleu foncé, brillant
donkerblau, glansend
azul oscuro, brillante
azul oscuro, lucente
mörkblá, blank
tummansininen, kiltävä
märke blá, skinnende
mörkblá, blank
Темно-голубой, блестящий
jmlé fútsó, okóuro, yuclónteró
koyu mavis, parlak
tmavomodrá, leská
sötét kék, fényes
temno plava, bleskajoča
inchis albastru, luciu
тъмно син, лъскаво
темно-синий, блеск
黒色マット

E Orange, clear 50
orange, klar
Pomarańczowy, czysty
orange, clair
orange, helder
naranja, claro
laranja, claro
arancione, chiaro
orange, klar
aranos, kirkas
orange, klar
orange, klar
оранжевый, чистый
portokali, ásuvas
portakal, seffaf
oranzöwa, čirá
narancs, áttétés-tisztá
pomarandzasta, jasna
portocaliu, clar
оранжево, ясно
pomarančový, prozopri
オランジュ, マット

F Red, matt 36
Czerwony, matowy
rouge, mat
rood, mat
carmin, mate
marrón, mate
castanho, fosco
marrone opaco
brun, matt
nauška, himmeä
brun, matt
brun, matt
красный, матовый
κόκκινο oáñño, jatt
lál rengi, mat
terveni, matná
piros, matt
rödeá, mat
carmin rosu, mate
karmin červeno, matov
червоный, матовый
赤色 マット

G Brown, matt
braun, matt
Brązowy, matowy
brun, mat
bruin, mat
marrón, mate
castanho, fosco
marrone opaco
brun, matt
nauška, himmeä
brun, matt
brun, matt
коричневый, матовый
үкpi, jatt
kahverengi, mat
inedá, matná
barna, matt
plava, mat
maro, mate
кафев, матово
коричневый, матово
褐色 マット

H Hellgrau, glanzend
Light grey, gloss
Jasnoszary, blyszczący
gris clair, brillant
Lichtgrís, glansend
gris claro, brillante
cinzento claro, lucente
grigio chiaro, lucente
juská, blank
vaaleanharmaa, kiltävä
lysgrá, skinnende
lysrá, blank
светло-серый, блестящий
ανοιχτόχρω, yuclónteró
acikgr, parlak
svélešedá, leská
világosszürke, fényes
svetlošiva, bleskajoča
gris deschis, luciu
светло-серый, лъскаво
світло-сірий, блеск
ライトグレー, 光沢

I Medium grey, matt
mittelgrau, matt
Srednioszary, matowy
gris moyen, mat
middlegrís, mat
gris medio, mate
cinzento-medio, fosco
grigio medio, opaco
miellgrá, matt
keskiharmma, himmeä
mellemgrá, matt
melomir, matt
средний-серый, матовый
gri meáoio, jatt
orta gri, ipék mat
střed šedá, matná
középszürke, matt
srednjesiva, matt
mediu gri, mate
средно сив, матово
середній сірий, матово
ミディアムグレー, マット

J Dark grey, matt
Dunkelgrau, matt
Ciemnoszary, matowy
gris foncé, matt
Donkergrís, mat
gris oscuro, mate
cinzento oscuro, fosco
grigio scuro, opaco
Körgrá, matt
tummanharmaa, himmeä
Markgrá, matt
Markgrá, matt
Темно-серый, матовый
үкpi okóuro, jatt
Koyu gri, ipék mat
tmavosivá, matná
Sötétészürke, matt
Temnosivá, mat
gris închis, mate
тъмно сив, матово
темно-сірий, матово
黒色マット

K Dark grey, matt
Dunkelgrau, matt
Ciemnoszary, matowy
gris foncé, matt
Donkergrís, mat
gris oscuro, mate
cinzento oscuro, fosco
grigio scuro, opaco
Körgrá, matt
tummanharmaa, himmeä
Markgrá, matt
Markgrá, matt
Темно-серый, матовый
үкpi okóuro, jatt
Koyu gri, ipék mat
tmavosivá, matná
Sötétészürke, matt
Temnosivá, mat
gris închis, mate
тъмно сив, матово
темно-сірий, матово
黒色マット

Required colours
Benötigte Farben
Potrzebne kolory
Peintures nécessaires
Benodigde kleuren
Pinturas necesarias
Tintas necessárias
Colori necessari
Använda färger
Blöt och fäst dekalerna
Kostuta siirtokuvaa vedessä ja aseta paikkaleen
Fukt motivet i varmt vatten och fäst det över på modellen
Dypp bildet i vann og sett det på
Переводную картинку намочить и нанести
Βουτηξτε τη χαρτοκιτριά στο νερό και τοποθετήστε τη
Çikartmayı suya yumuflatın ve koyun
Obtisk namočit ve vodě a umístit
a matrică în apă caldă și să o aplici
Preslikač potopiti v vodu in zatem nanašati
Rum-Se Immoaie și se aplică decalcomani
BUL-Намиснете и прилагане на водени
UA Замочити і застосувати наклею

Soak and apply decals
Abziehbild in Wasser einweichen und anbringen
Zmęczyć kalkonię w wodzie a następnie nakleić
Mouiller et appliquer les décalcomanies
Transfer in water even laten weken en aanbrengen
Remojar y aplicar las calcomanías
Pôr de molho em água e aplicar o decalque
Immergere in acqua ed applicare decalcomanie
Blöt och fäst dekalerna
Kostuta siirtokuvaa vedessä ja aseta paikkaleen
Fukt motivet i varmt vatten och fäst det över på modellen
Dypp bildet i vann og sett det på
Переводную картинку намочить и нанести
Βουτηξτε τη χαρτοκιτριά στο νερό και τοποθετήστε τη
Çikartmayı suya yumuflatın ve koyun
Obtisk namočit ve vodě a umístit
a matrică în apă caldă și să o aplici
Preslikač potopiti v vodu in zatem nanašati
Rum-Se Immoaie și se aplică decalcomani
BUL-Намиснете и прилагане на водени
UA Замочити і застосувати наклею

Number of working steps
Anzahl der Arbeitsgänge
Liczba operacji
Nombre d'étapes de travail
Het aantal bouwstappen
Het aantal bouwstappen
Número de operaciones de trabajo
Número de etapas de trabalho
Numero di passaggi
Antal arbetsmoment
Työväleiden lukumäärä
Antall arbeidstrinn
Antall arbeidstrinn
Количество операций
αριθμός των εργασιών
İş safhalarının sayısı
Počet pracovních operací
a munkafolyamatok száma
Številka koraka montaže
Numărul de etape de lucru
Брой работни стъпки
Кількість робочих кроків

Adhesive tape
Klebeband
Taśma klejąca
Dévidoir de ruban adhésif
Plakband
Cinta adhesiva
Fita adesiva
Nastro adesivo
Tejp
Teippi
Tape
Tape
Клейкая лента
κόλλητική ταινία
Yapıştırma bandı
Lepici páska
ragasztószalag
Traka z lepilom
Bandă adezivă
Лепенки
Скотч

Glue and clock icons

6 STEP

Fuselage Assembly
Montaz kadluba
Einbau der Rumpfhälfte
Fixation du fuselage
胴体の組み立て

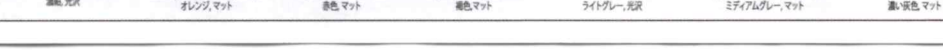

7 STEP

8 STEP



9
STEP

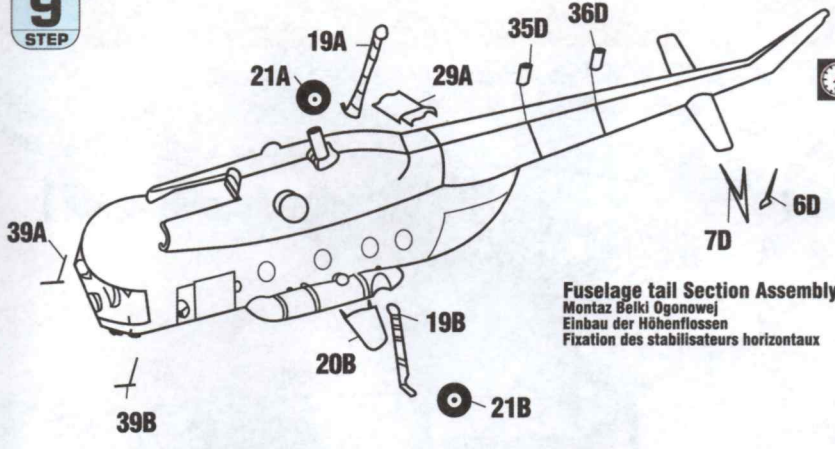

Fuselage tail Section Assembly
Montaż Belki Ogonowej
Einbau der Höhenflossen
Fixation des stabilisateurs horizontaux

UK Allow the parts to dry
Bauteile trocken lassen
Pozostawić do wyschnięcia
Laisser sécher les pièces
Oderdelen laten drogen
Dejar secar las piezas
Dejar secar os componentes
Far asciugarsi i componenti
anna osien kuivua
La delene tørke
Lad komponenterne tørre
Låt byggdelarna torka
Дать деталям высохнуть
Αφήστε το μέρος να μ στεγνώνει
Yapı parçalarını kurumaya bırakınız
Jednotlivě díly nechte zaschnout
Alkatrészeket hagyja száradni
Pustite da sestavni deli posušijo
Se lasă să se usuce piese
Оставьте части да изсъхнат
Дайте высохнуть детали

10
STEP

Upper Fuselage Intallation
Zainstalowanie górnej części kadłuba
Einbau Die Ober Rumpf
Fixation des Supérieure du fuselage

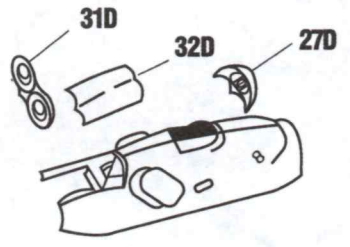

11
STEP



Paint
Bemalen
Pomalować
Peindre
Beschilderen
Pintar
Dipingere
Pintar
Måla
Male
Maalaa
Раскрасить
Befesteni
Ізобразити
Pomalovat
Boyamak
Poslikati
Vopsea
Черя
Малювати

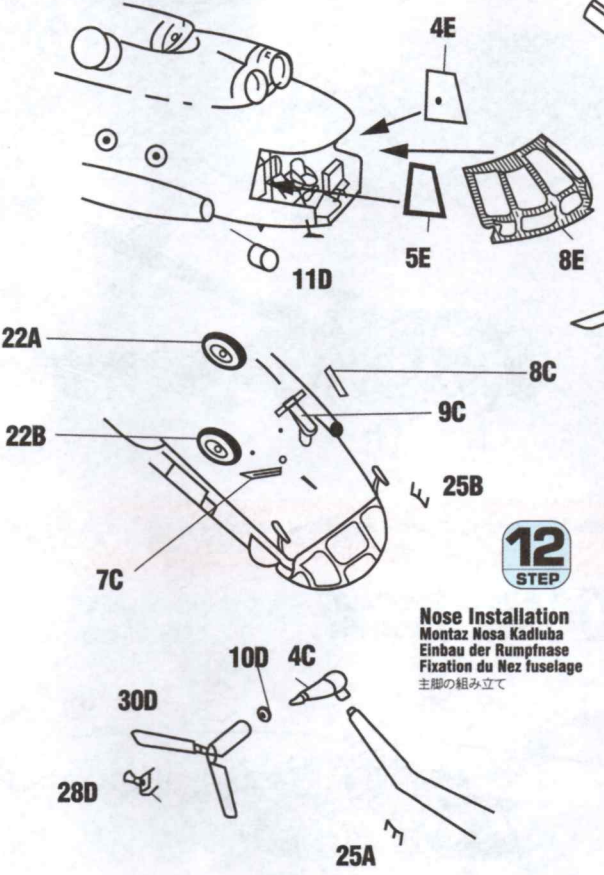

Nose Installation
Montaż Nosa Kadłuba
Einbau der Rumpfnase
Fixation du Nez fuselage
主艀の組み立て

14
STEP

Main Rotor Assembly
Montaż Wirnika Głównego
Zusammensetzung der Hauptrotor
Ensamble du Rotor Principal
Montaje de Rotor

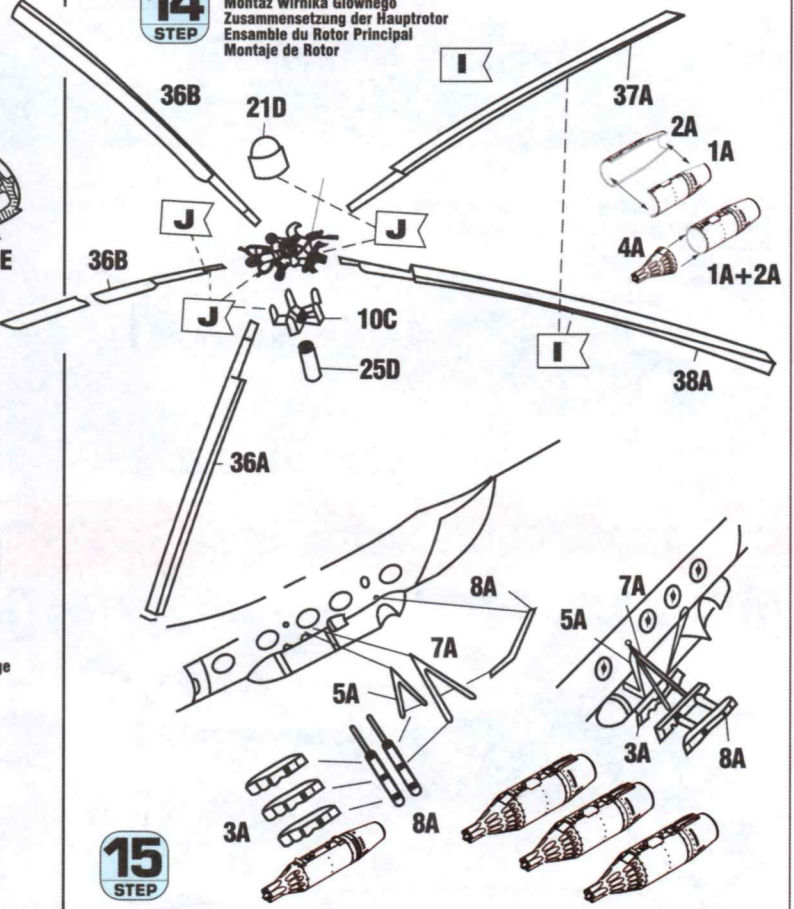

15
STEP

13
STEP

GB.Numbering of parts • D.Nummerierung von Teilen • PL.Numeracja części • F.la Numérotation des pièces • CZ.Číslování dílů • RUС. Нумерация частей

NL.Nummering van onderdelen • ESP.Numeración de las piezas
POR.Numeração das peças (Numerazione delle parti)
S.Nummering av delar (FIN.Numerointi osien)
DEN.Nummerering af dele (NOR.Nummerering av deler)
GR.Η αριθμολογία των τμημάτων (TUR.Parçaların Numaralandırma)
H.Számozása alkatrészek (SK.Číslovanie dielov)
Rum.Numerotarea pieselor (BUL.Номерирание на части)
UA.Нумерація частин

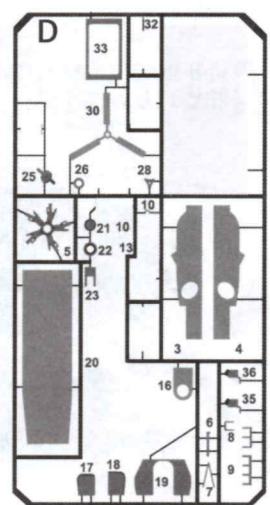
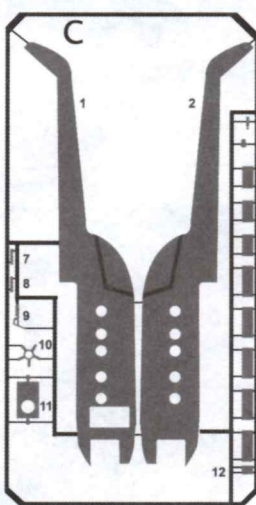
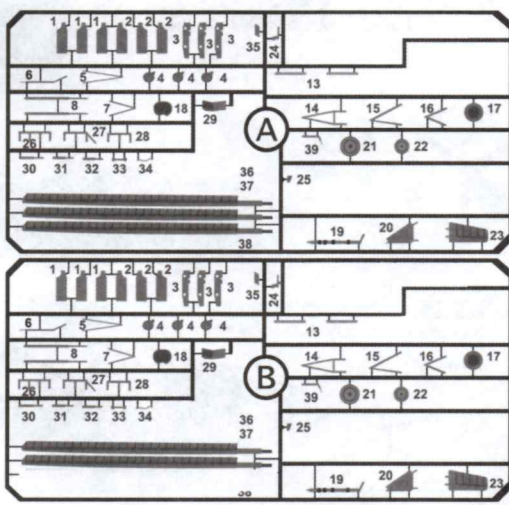
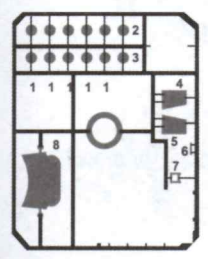

Marking & Painting

•DEN. Bemaling og markeringer Guide •NOR. Maleri og Markings Guide •RUS. Окраска и маркировка руководство •GR. Ζωγραφική και Σημανσεις Οδηγός •CZ. Malování a Značení

3 MI-8T Vzdušné síly Armády České Republiky (Czech Rep. Air Force), Prerov A.B., Czech Rep. 1962

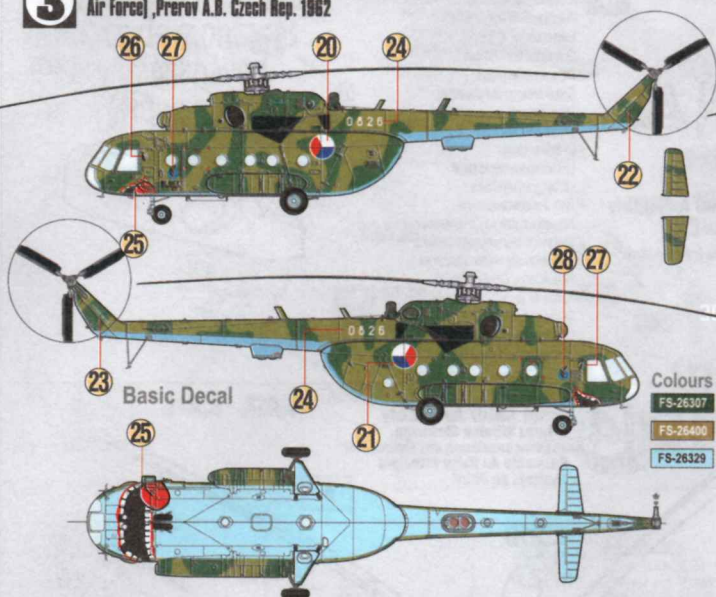

Colours
FS-26307
FS-26400
FS-26329

4 MI-8T Vzdušné síly Ozbrojených Sílov Slovenskej Republiky (Slovak Rep. Air Force), Bratislava A.B., Slovakia 1980s



Ex-Czechoslovakian Camouflage
After Czechoslovakia peacefully split into Czech Republic and Slovakia 0826 was transferred to Slovak Air Force remaining Camouflage. After overhaul the 3 colors fresh camouflage was applied.

5 MI-17 Военно Въздушни Сили, Жытомир, Украина, 1995 Zytomir A.B., Ukraine. 1990

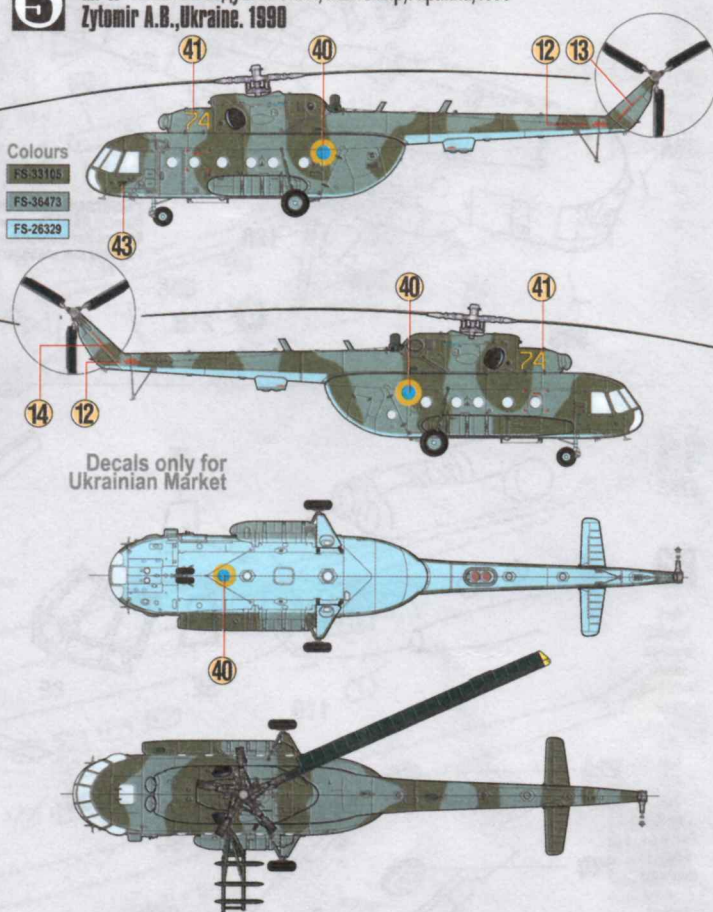

Colours
FS-33105
FS-36473
FS-26329

Decals only for Ukrainian Market

•TUR. Kılavuz Boyama ve Markalama •H. Festék rendszer és jelölések •SK. Malovanie a značenie Guide •Rum. Marcarea si pictura Ghid

•BUL. Живопис и маркировка Ръководство •UA. Маркування та живопис керівництво

6 MI-17 Военновъздушни сили, BBC, Bulgarian Air Force, Plovdiv, Bulgaria. 1990s



Colours
FS-34138
FS-33440
FS-26329

Decals only for Bulgarian Market

8 MI-17 Fuerza Aerea Mexicana, Cartahena A.B., Mexico 1995

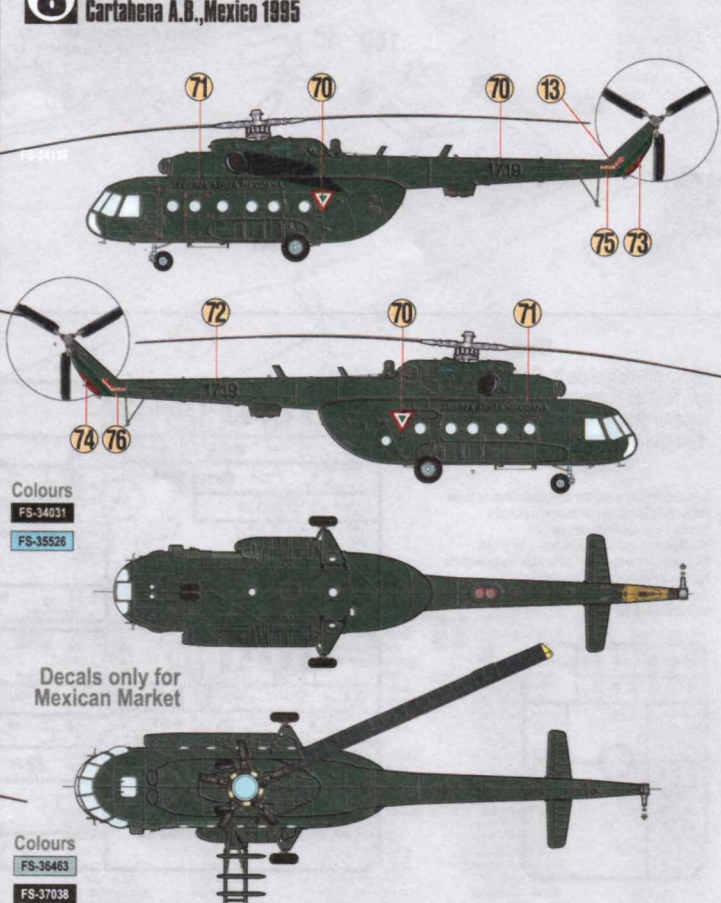

Colours
FS-34031
FS-35526

Decals only for Mexican Market

Colours
FS-36463
FS-37038

7 MI-17 Magyar Légierő Hungarian Defence Forces, Szolnok A.B., Hungary 1961

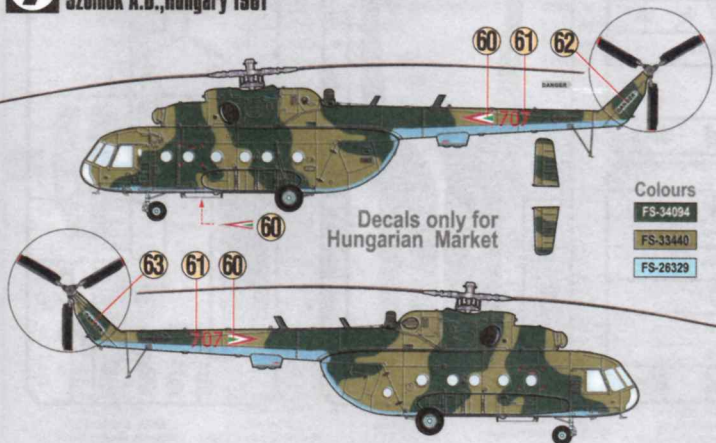

Colours
FS-34094
FS-33440
FS-26329

Decals only for Hungarian Market